



POCKET COLORIMETER™ II
ANALYSIS SYSTEMS

INSTRUCTION MANUAL

Chlorine (Cl₂)
Mid-Range (MR) and High Range (HR)

Important Note

This manual is intended for use with the following Pocket Colorimeter™ II instrument:

Chlorine (Cl₂)

Cat. No. 59530-62

Table of Contents

Safety Precautions	1—5
Laboratory Safety	1—5
Use of Hazard Information	1—6
Precautionary Labels	1—7
Specifications	1—9
Instrument Keys and Display	1—13
Instrument Cap Cord	1—14
Chlorine, Free and Total, MR	1—17
Measuring Hints	1—17
Accuracy Check	1—23
Interferences	1—25
Method Performance	1—28
Chlorine, Free and Total, HR	1—29
Measuring Hints	1—29
Accuracy Check	1—34
Interferences	1—36
Method Performance	1—37
Spec[√]™ Secondary Standards for DPD Chlorine	1—39

Table of Contents, continued

Using the Spec ^v Standards.....	1—40
Summary of Method	1—41
Replacement Parts	1—42
Instrument Operation	2—3
Key Functions.....	2—3
Menu Selections.....	2—4
Switching Ranges.....	2—4
Setting the Time.....	2—4
Recalling Stored Measurements.....	2—5
Battery Installation.....	2—6
Error Codes	2—9
Error Messages.....	2—9
Standard Calibration Adjust	2—13
Certification	2—15
How to Order	2—21
Repair Service	2—23
Warranty	2—24

Safety Precautions

Please read this entire manual before unpacking, setting up or operating this equipment. Pay attention to all danger and caution statements. Failure to do so could result in serious injury to the operator or damage to the equipment.

Make sure that the protection provided by this equipment is not impaired, do not use or install this equipment in any manner other than that specified in this manual.

In no event will the manufacturer be liable for direct, indirect, special, incidental or consequential damages resulting from any defect or omission in this manual. The manufacturer reserves the right to make changes in this manual and the products it describes at any time, without notice or obligation.

Revised editions are found on the manufacturer's website.

Laboratory Safety

As part of good laboratory practice, please familiarize yourself with the reagents used in these procedures. Read all product labels and the material safety data sheets (MSDS) before using them. It is always good practice to

Safety Precautions, continued

wear safety glasses when handling chemicals. Follow instructions carefully. Rinse thoroughly if contact occurs. If you have questions about reagents or procedures, please contact the manufacturer or distributor.

Use of Hazard Information

WARNING

Indicates a potentially or imminently hazardous situation which, if not avoided, could result in death or serious injury.

CAUTION

Indicates a potentially hazardous situation that may result in minor or moderate injury.

NOTICE

Indicates a situation which, if not avoided, may cause damage to the instrument. Information that requires special emphasis.

Precautionary Labels

Read all labels and tags attached to the instrument. Personal injury or damage to the instrument could occur if not observed. A symbol on the instrument is referenced in the manual with a precautionary statement.

	<p>This is the safety alert symbol. Obey all safety messages that follow this symbol to avoid potential injury. If on the instrument, refer to the instruction manual for operation or safety information.</p>
	<p>Electrical equipment marked with this symbol may not be disposed of in European public disposal systems after 12 August of 2005. In conformity with European local and national regulations (EU Directive 2002/96/EC), European electrical equipment users must now return old or end-of life equipment to the Producer for disposal at no charge to the user.</p> <p>Note: <i>For return for recycling, please contact the equipment producer or supplier for instructions on how to return end-of-life equipment, producer-supplied electrical accessories, and all auxiliary items for proper disposal.</i></p>

Safety Precautions, continued

Specifications

Lamp: Light emitting diode (LED)

Detector: Silicon photodiode

Photometric precision: ± 0.0015 Abs

Filter bandwidth: 15 nm

Wavelength: 528 nm

Absorbance range: 0–2.5 Abs

Dimensions: 3.2 x 6.1 x 15.2 cm (1.25 x 2.4 x 6 inches)

Weight: 0.2 kg (0.43 lb)

Sample cells: 1 cm (5–10 mL), 25 mm (10 mL)

Operating conditions: 0 to 50 °C (32 to 122 °F); 0 to 90% relative humidity (noncondensing)

Power supply: Four AAA alkaline batteries; approximate life is 2000 tests*

* Backlight usage will decrease battery life.

OPERATION

DANGER

Handling chemical samples, standards, and reagents can be dangerous. Review the necessary Material Safety Data Sheets and become familiar with all safety procedures before handling any chemicals.

DANGER

La manipulation des échantillons chimiques, étalons et réactifs peut être dangereuse. Lire les Fiches de Données de Sécurité des Produits (FDSP) et se familiariser avec toutes les procédures de sécurité avant de manipuler tous les produits chimiques.

PELIGRO

La manipulación de muestras químicas, estándares y reactivos puede ser peligrosa. Revise las fichas de seguridad de materiales y familiarícese con los procedimientos de seguridad antes de manipular productos químicos.

GEFAHR

Das Arbeiten mit chemischen Proben, Standards und Reagenzien ist mit Gefahren verbunden. Es wird dem Benutzer dieser Produkte empfohlen, sich vor der Arbeit mit sicheren Verfahrensweisen und dem richtigen Gebrauch der Chemikalien vertraut zu machen und alle entsprechenden Material Sicherheitsdatenblätter aufmerksam zu lesen.

PERIGO

A manipulação de amostras, padrões e reagentes químicos pode ser perigosa. Reveja a folha dos dados de segurança do material e familiarize-se com todos os procedimentos de segurança antes de manipular quaisquer produtos químicos.

PERICOLO

La manipolazione di campioni, standard e reattivi chimici può essere pericolosa. La preghiamo di prendere conoscenza delle Schede Tecniche necessarie legate alla Sicurezza dei Materiali e di abituarsi con tutte le procedure di sicurezza prima di manipolare ogni prodotto chimico.

Instrument Keys and Display

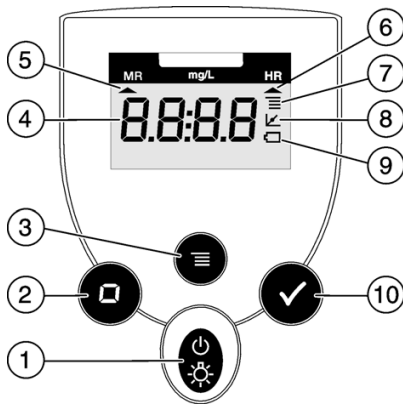

Item	Description
1	POWER/BACKLIGHT Key
2	ZERO/SCROLL Key
3	MENU Key
4	Numeric Display
5	Range Indicator
6	Range Indicator
7	Menu Indicator
8	Calibration Adjusted Indicator
9	Battery Low Indicator
10	READ/ENTER Key

Instrument Cap Cord

The instrument cap for the Pocket Colorimeter™ II doubles as a light shield. Accurate measurements cannot be obtained unless the sample or blank is covered with the cap. Use the instrument cap cord to secure the cap to the body of the colorimeter and prevent loss of the cap. See [Figure 1 on page 1—15](#).

1. Loop the instrument cap cord through the ring on the cap.
2. Remove the battery compartment cover. Press the knotted end of the cord into the hole indicated by the arrow.
3. Slide the cord into the slot on the battery compartment cover. Snap the cover into place.

Instrument Cap Cord, continued

Figure 1 Attaching the Instrument Cap Cord

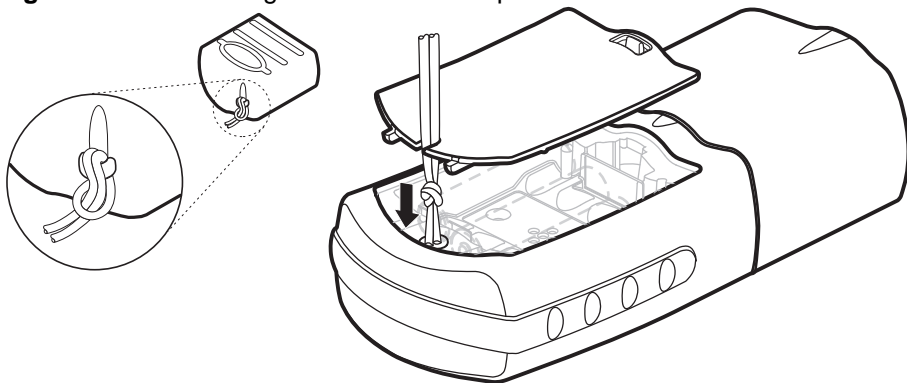

Chlorine, Free and Total, MR (0.05 to 4.00 mg/L Cl₂)

Method 10245 (Free): For water, treated water, estuary water and seawater

Method 10250 (Total): For water, treated water, wastewater, estuary water and seawater

DPD Method*

USEPA accepted for reporting drinking water analyses** (free and total chlorine) and wastewater analyses** (total chlorine only)

Measuring Hints

- Analyze samples immediately. Do not use plastic containers to collect samples.
- For best results, dedicate a set of cells to each free chlorine and total chlorine test.
- Cold waters can cause condensation on the sample cells during color development. Examine the sample cells for condensation before reading.

* Adapted from *Standard Methods for the Examination of Water and Wastewater*.

** Procedure is equivalent to USEPA method 330.5 for wastewater and Standard Method 4500-Cl G for drinking water.

NOTICE

The Pocket Colorimeter II is designed to measure solutions contained in sample cells. **DO NOT** dip the meter in the sample or pour the sample directly into the cell holder.

Using Powder Pillows (USEPA accepted for reporting)

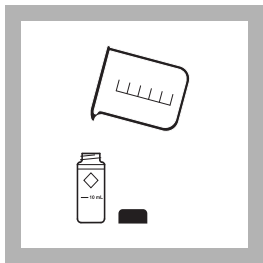

1. Fill a 10-mL cell with sample (the blank). Cap.

Note: Samples must be analyzed immediately and cannot be preserved for later analysis.

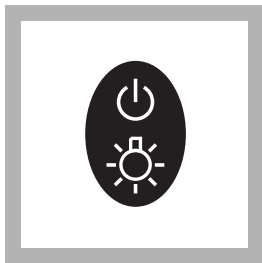

2. Press the **POWER** key to turn the meter on. The arrow should indicate the medium range channel (MR).

Note: See [page 2—4](#) for information on selecting the correct range channel.

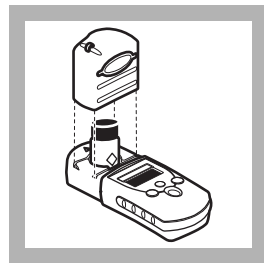

3. Remove the meter cap. Place the blank in the cell holder with the diamond mark facing the keypad. Fit the meter cap over the cell compartment to cover the cell.

Note: Wipe excess liquid and finger prints off sample cells.

Chlorine, Free and Total, MR, continued



4. Press ZERO/SCROLL.
The display will show “- - - -” then “0.00”.

Remove the blank from the cell holder.

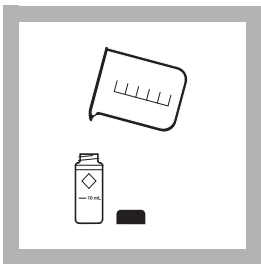

5. Fill a second 10-mL cell to the 10-mL line with sample.

***Note:** Do not use the same sample cells for free and total chlorine analysis without thoroughly rinsing the cells with sample between free and total tests.*



6. Add the contents of one DPD Free Chlorine Powder Pillow or one DPD Total Chlorine Powder Pillow for 25-mL samples to the sample cell (the prepared sample).

Chlorine, Free and Total, MR, continued

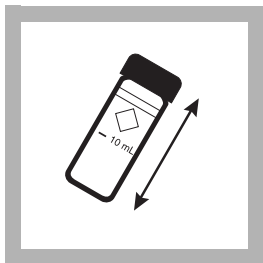

7. Cap and shake gently for 20 seconds.

Note: *Shaking dissipates bubbles that may form in samples with dissolved gases.*

Note: *A pink color will develop if chlorine is present.*

Note: *Accuracy is not affected by undissolved powder.*

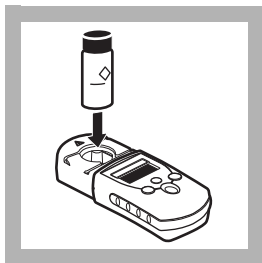

8. For **free** chlorine, wipe excess liquid and fingerprints from the sample cell. Put the prepared sample cell in the cell holder, then cover the cell with the instrument cap. Proceed to step 10 within **one** minute after adding the DPD Free Pillow.

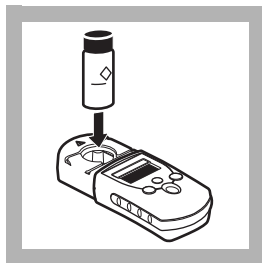

9. For **total** chlorine, wait **3 to 6** minutes after adding the DPD Total Pillow. After the reaction time, wipe excess liquid and fingerprints from the sample cell. Put the prepared sample in the cell holder and cover the cell with the instrument cap. Proceed to step 10.

Chlorine, Free and Total, MR, continued



10. Press **READ/ENTER**. The instrument will show “- - -” followed by the results in mg/L chlorine.

Note: *If the sample temporarily turns yellow after reagent addition, or if the display shows overrange (page 2—12) dilute a fresh sample and repeat the test. A slight loss of chlorine may occur because of the dilution. Multiply the result by the appropriate dilution factor.*

Accuracy Check

Standard Additions Method

1. Use the ampule breaker to snap the neck off a Chlorine Standard Solution Ampule, 50–75 mg/L Cl_2 .
2. Use a TenSette® pipet to add 0.1, 0.2, and 0.3 mL of standard to three 10-mL samples. Swirl gently to mix.
3. Analyze a 10-mL aliquot of each sample as described in the procedure. Each 0.1 mL of standard will cause an incremental increase in chlorine. The exact value depends on the concentration of the ampule standard. Check the certificate enclosed with the ampules for the chlorine concentration and calculation of the expected chlorine increase.

Standard Solution Method

Standard solutions for chlorine are difficult and time-consuming to prepare. Errors can occur if attention to detail is not addressed during preparation of the standards. The calibration curve is prepared under rigorous analytical laboratory conditions. Use the factory calibration for most normal testing.

Chlorine, Free and Total, MR, continued

A verification of the internal, factory set calibration may be required by a regulatory official or primacy agency. To meet this requirement, a chlorine check standard may be prepared and used to verify or adjust the calibration curve using the Standard Calibration Adjust feature (see [page 2—13](#) for more information).

The concentration of the prepared check standard must be determined with an alternate instrument such as a spectrophotometer, colorimeter, or by using an alternate method such as amperometric titration. Alternately, the chlorine check standard may be prepared directly by following the instructions given in *Determination of Residual Chlorine in Drinking Water Using an On-Line Chlorine Analyzer*, DOC316.53.01302. The concentration of the chlorine standard for the MR procedure must be between 1.00 and 3.00 mg/L chlorine if the standard adjust feature is used to adjust the calibration curve.

The Chlorine Pocket Colorimeter II can be used to meet the requirements of USEPA Method 334.0—*Determination of Residual Chlorine in Drinking Water Using an On-Line Chlorine Analyzer*.

The procedure and requirements for meeting EPA Method 334.0 can be downloaded directly from www.hach.com. Search for DOC316.53.01302.

Interferences

Interfering Substance	Interference Levels and Treatments
Acidity	Greater than 150 mg/L CaCO ₃ . May not develop full color or color may fade instantly. Neutralize to pH 6–7 with 1 N Sodium Hydroxide. Determine amount to be added on a separate 10-mL sample, then add the same amount to the sample being tested. Correct for the additional volume.
Alkalinity	Greater than 250 mg/L CaCO ₃ . May not develop full color or color may fade instantly. Neutralize to pH 6–7 with 1 N Sulfuric Acid. Determine amount to be added on a separate 10-mL sample, then add the same amount to the sample being tested. Correct for the additional volume.
Bromine, Br ₂	Interferes at all levels
Hardness	No effect at less than 1,000 mg/L as CaCO ₃
Iodine, I ₂	Interferes at all levels

Chlorine, Free and Total, MR, continued

Interfering Substance	Interference Levels and Treatments
Manganese, Oxidized (Mn ⁴⁺ , Mn ⁷⁺) or Chromium, Oxidized (Cr ⁶⁺)	<ol style="list-style-type: none"><li data-bbox="457 215 888 246">1. Adjust sample pH to 6–7.<li data-bbox="457 256 1164 329">2. Add 3 drops Potassium Iodide (30-g/L) (Cat. No. 343-32) to a 10-mL sample.<li data-bbox="457 339 881 370">3. Mix and wait one minute.<li data-bbox="457 381 1138 453">4. Add 3 drops Sodium Arsenite (5-g/L) (Cat. No. 1047-32) and mix.<li data-bbox="457 464 1098 536">5. Analyze 10 mL of the treated sample as described in the procedure.<li data-bbox="457 547 1177 650">6. Subtract the result from this test from the original analysis to obtain the correct chlorine concentration.

Chlorine, Free and Total, MR, continued

Interfering Substance	Interference Levels and Treatments																									
Monochloramine	<p>For conventional free chlorine disinfection (beyond the breakpoint), monochloramine concentrations are very low. If monochloramine is present in the sample, its interference in the free chlorine test varies with the temperature, the relative amount of monochloramine to free ammonia, and the time required to do the analysis. Approximate interference levels of monochloramine in the free chlorine test are listed below (as mg/L Cl₂).</p> <table border="1" style="margin-left: auto; margin-right: auto;"> <thead> <tr> <th style="text-align: center;">NH₂Cl</th> <th colspan="4" style="text-align: center;">Sample Temperature °C (°F)</th> </tr> <tr> <th style="text-align: center;">(as Cl₂)</th> <th style="text-align: center;">5 (40)</th> <th style="text-align: center;">10 (50)</th> <th style="text-align: center;">20 (68)</th> <th style="text-align: center;">30 (83)</th> </tr> </thead> <tbody> <tr> <td style="text-align: center;">1.2</td> <td style="text-align: center;">0.2</td> <td style="text-align: center;">0.2</td> <td style="text-align: center;">0.3</td> <td style="text-align: center;">0.3</td> </tr> <tr> <td style="text-align: center;">2.5</td> <td style="text-align: center;">0.4</td> <td style="text-align: center;">0.5</td> <td style="text-align: center;">0.6</td> <td style="text-align: center;">0.6</td> </tr> <tr> <td style="text-align: center;">3.5</td> <td style="text-align: center;">0.5</td> <td style="text-align: center;">0.6</td> <td style="text-align: center;">0.7</td> <td style="text-align: center;">0.8</td> </tr> </tbody> </table>	NH ₂ Cl	Sample Temperature °C (°F)				(as Cl ₂)	5 (40)	10 (50)	20 (68)	30 (83)	1.2	0.2	0.2	0.3	0.3	2.5	0.4	0.5	0.6	0.6	3.5	0.5	0.6	0.7	0.8
NH ₂ Cl	Sample Temperature °C (°F)																									
(as Cl ₂)	5 (40)	10 (50)	20 (68)	30 (83)																						
1.2	0.2	0.2	0.3	0.3																						
2.5	0.4	0.5	0.6	0.6																						
3.5	0.5	0.6	0.7	0.8																						
Ozone	Interferes at all levels.																									

Method Performance

Estimated Detection Limit (EDL) = 0.05 mg/L

Typical precision (95% confidence interval) = 2.00 ±0.09 mg/L

Chlorine, Free and Total, HR (0.1 to 10.0 mg/L Cl₂)

For water, treated water, estuary water and seawater (Free Chlorine)

For water, treated waters, wastewater, estuary water and seawater
(Total Chlorine)

DPD Method*

USEPA accepted for reporting drinking water analyses (free and total chlorine) and wastewater analyses (total chlorine).

Measuring Hints

- If the chlorine concentration is typically less than 4 mg/L, use the medium range (MR) procedure.
- Analyze samples immediately. Do not use plastic containers to collect samples. For best results, dedicate a set of sample cells to each test (free and total).

* Adapted from *Standard Methods for the Examination of Water and Wastewater*.

Chlorine, Free and Total, HR, continued

- If the sample temporarily turns yellow after reagent addition or shows overrange (page 2—12), dilute a fresh sample and repeat the test. A slight loss of chlorine may occur. Multiply the result by the dilution factor.
- High range free chlorine determinations are subject to variable levels of interferences from monochloramine. See Interferences on page 1—36.
- Cold waters can cause condensation on the sample cells during color development. Examine the sample cells for condensation before reading.

NOTICE

The Pocket Colorimeter II is designed to measure solutions contained in sample cells. **DO NOT** dip the meter in the sample or pour the sample directly into the cell holder.

Using Powder Pillows

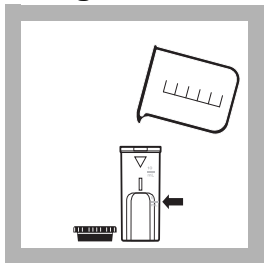

1. Fill a 1-cm/10-mL cell with sample (the blank). Cap.

Note: Samples must be analyzed immediately and cannot be preserved for later analysis.

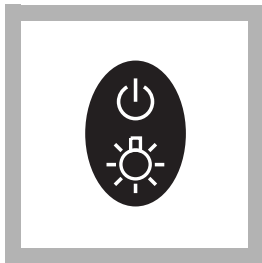

2. Press the **POWER** key to turn the meter on. The arrow should indicate the high range channel (HR).

Note: See [page 2—4](#) for information on selecting the correct range channel.



3. Remove the meter cap. Place the blank into the cell holder, with the diamond mark facing the back of the cell holder. Cover the cell with the cap.

Note: Wipe liquid off sample cells.

Chlorine, Free and Total, HR, continued

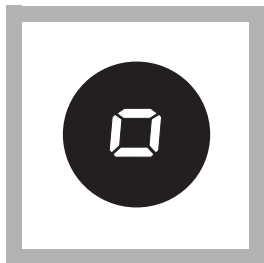

4. Press: ZERO/SCROLL
The display will show
“- - - -” followed by “0.0”.

Remove the blank.

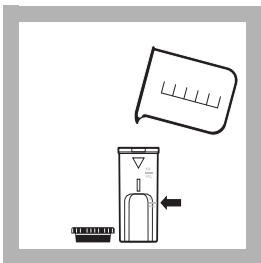

5. Fill another 1-cm/10-mL
sample cell to the 5-mL line
with sample.

Note: Do not use the same
sample cells for free and
total chlorine without
thoroughly rinsing the cells
between the free and total
tests.

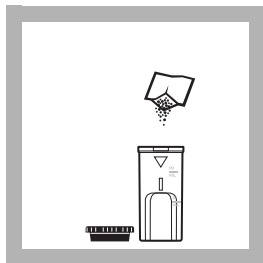

6. Add the contents of one
DPD **Free** Chlorine or one
DPD **Total** Chlorine
Powder Pillows for 25-mL
samples to the sample cell
(the prepared sample).
Cap the cell and shake
gently for 20 seconds.
Wipe the cell.

Note: Gentle shaking
dissipates bubbles which
may form in samples
containing dissolved gases.

Chlorine, Free and Total, HR, continued



7. For **free** chlorine, wipe excess liquid and fingerprints from the sample cell. Put the prepared sample cell in the cell holder, then cover the cell with the instrument cap. Proceed to step 9 within **one** minute after adding the DPD Free Pillows.



8. For **total** chlorine, wait **3 to 6** minutes after adding the DPD Total Pillow. After the reaction time, wipe excess liquid and fingerprints from the sample cell. Put the prepared sample in the cell holder and cover the cell with the instrument cap. Proceed to step 9.



9. Press **READ/ENTER**. The instrument will show “- - -” followed by the results in mg/L chlorine (Cl_2).

Accuracy Check

Standard Additions Method

- a. Use the ampule breaker to snap the neck off a high range Chlorine Standard Solution Ampule, 50–70 mg/L Cl_2 .
- b. Use a TenSette® pipet to add 0.1, 0.2, and 0.3 mL of standard to three 5-mL samples. Swirl gently to mix.
- c. Analyze each sample as described in the procedure. Each 0.1 mL of standard will cause an incremental increase in chlorine. The exact value depends on the concentration of the ampule standard. Check the certificate enclosed with the ampules for calculation of the expected increase in the chlorine concentration.

Standard Solution Method

Standard solutions for chlorine are difficult and time-consuming to prepare. Errors can occur if attention to detail is not addressed during preparation of the standards. The calibration curve is prepared under rigorous analytical laboratory conditions. Use the factory calibration for most normal testing.

Chlorine, Free and Total, HR, continued

A verification of the internal, factory set calibration may be required by a regulatory official or primacy agency. To meet this requirement, a chlorine check standard may be prepared and used to verify or adjust the calibration curve using the Standard Calibration Adjust feature (see [page 1—39](#) for more information).

The concentration of the prepared check standard must be determined with an alternate instrument such as a spectrophotometer, colorimeter, or by using an alternate method such as amperometric titration. Alternately, the chlorine check standard may be prepared directly by following the instructions given in *Determination of Residual Chlorine in Drinking Water Using an On-Line Chlorine Analyzer*, DOC316.53.01302. The concentration of the chlorine standard for the HR procedure must be between 4.5 and 7.0 mg/L chlorine if the standard adjust feature is used to adjust the calibration curve.

The Chlorine Pocket Colorimeter II can be used to meet the requirements of EPA Method 334.0—*Determination of Residual Chlorine in Drinking Water Using an On-Line Chlorine Analyzer*.

The procedure and requirements for meeting EPA Method 334.0 can be downloaded directly from www.hach.com. Search for DOC316.53.01302.

Chlorine, Free and Total, HR, continued

Interferences

Interfering Substance	Interference Levels and Treatments																									
Monochloramine	<p>For conventional free chlorine disinfection (beyond the breakpoint), monochloramine concentrations are very low. If monochloramine is present in the sample, its interference in the free chlorine test varies with the temperature, the relative amount of monochloramine to free ammonia, and the time required to do the analysis. Approximate interference levels of monochloramine in the free chlorine test are listed below (as mg/L Cl₂).</p> <table border="1" data-bbox="460 533 1151 764"><thead><tr><th data-bbox="467 536 598 588">NH₂Cl (as Cl₂)</th><th colspan="4" data-bbox="605 536 1144 588">Sample Temperature °C (°F)</th></tr><tr><th data-bbox="467 593 598 635"></th><th data-bbox="605 593 736 635">5 (40)</th><th data-bbox="743 593 875 635">10 (50)</th><th data-bbox="881 593 1013 635">20 (68)</th><th data-bbox="1019 593 1151 635">30 (83)</th></tr></thead><tbody><tr><td data-bbox="467 640 598 681">1.2</td><td data-bbox="605 640 736 681">0.2</td><td data-bbox="743 640 875 681">0.2</td><td data-bbox="881 640 1013 681">0.3</td><td data-bbox="1019 640 1151 681">0.3</td></tr><tr><td data-bbox="467 686 598 728">2.5</td><td data-bbox="605 686 736 728">0.4</td><td data-bbox="743 686 875 728">0.5</td><td data-bbox="881 686 1013 728">0.6</td><td data-bbox="1019 686 1151 728">0.6</td></tr><tr><td data-bbox="467 733 598 774">3.5</td><td data-bbox="605 733 736 774">0.5</td><td data-bbox="743 733 875 774">0.6</td><td data-bbox="881 733 1013 774">0.7</td><td data-bbox="1019 733 1151 774">0.8</td></tr></tbody></table>	NH ₂ Cl (as Cl ₂)	Sample Temperature °C (°F)					5 (40)	10 (50)	20 (68)	30 (83)	1.2	0.2	0.2	0.3	0.3	2.5	0.4	0.5	0.6	0.6	3.5	0.5	0.6	0.7	0.8
NH ₂ Cl (as Cl ₂)	Sample Temperature °C (°F)																									
	5 (40)	10 (50)	20 (68)	30 (83)																						
1.2	0.2	0.2	0.3	0.3																						
2.5	0.4	0.5	0.6	0.6																						
3.5	0.5	0.6	0.7	0.8																						

See additional [Interferences on page 1—25](#).

Method Performance

Estimated Detection Limit (EDL) = 0.1 mg/L

Typical precision (95% confidence interval) = 5.0 ±0.2 mg/L

Chlorine, Free and Total, HR, continued

Spec \checkmark TM Secondary Standards for DPD Chlorine

The DPD Chlorine Spec \checkmark Secondary Standards are available to quickly check the repeatability of the Pocket ColorimeterTM II instrument (see Replacement Parts on page 1—42).

After initial measurements for the Spec \checkmark standards are collected in the appropriate range channel, the standards can be re-checked as often as desired to ensure the instrument is working consistently.

The standards do not ensure reagent quality nor do they ensure the accuracy of the test results. Analysis of real standard solutions using the kit reagents is required to verify the accuracy of the entire Pocket Colorimeter system. The Spec \checkmark Standards should *NEVER* be used to calibrate the instrument. The certificate of analysis lists the expected value and tolerance for each Spec \checkmark Standard.

Note: *Before proceeding, make sure the instrument is in the correct range channel. See Switching Ranges on page 2—4.*

Using the Spec $\sqrt{\text{TM}}$ Standards

1. Place the colorless Spec $\sqrt{\text{TM}}$ blank into the cell holder with the alignment mark facing the keypad. Tightly cover the cell with the instrument cap.
2. Press **ZERO**. The display will show “0.00” (0.0, if using HR SpecChecks).
3. Place the STD 1 cell into the cell holder. Tightly cover the cell with the instrument cap.
4. Press **READ/ENTER**. Record the concentration measurement.
5. Repeat steps 3 and 4 with cells labeled STD 2 and STD 3.
6. Compare these measurements with previous measurements to verify the instrument is performing consistently. (If these are the first measurements, record them for comparison with later measurements.)

Note: *If the instrument has a user-adjusted calibration, initial standard measurements of the Spec $\sqrt{\text{TM}}$ Standards will need to be performed again for the user-adjusted calibration.*

Summary of Method

Chlorine can be present in water as free chlorine and as combined chlorine. Both forms can coexist in the same solution and can be determined together as total chlorine. Free chlorine is present as hypochlorous acid or hypochlorite ion. Combined chlorine represents a combination of chlorine-containing compounds including but not limited to monochloramine, dichloramine, nitrogen trichloride, and other chloro derivatives. The combined chlorine oxidizes iodide (I^-) to iodine (I_2). The iodine and free chlorine reacts with DPD (N,N-diethyl-p-phenylenediamine) to form a red solution. The color intensity is proportional to the total chlorine concentration. To determine the concentration of combined chlorine, run a free chlorine test and a total chlorine test. Subtract the results of the free chlorine test from the total chlorine test to obtain the combined chlorine concentration.

The range of analysis using the DPD method for chlorine can be extended by adding more indicator in proportion to sample volume. For example, in the medium range test, a powder pillow designed for a 25 mL sample is added to a 10 mL sample to increase the test range. In the high range procedure, this pillow is added to a 5 mL sample, to further extend the range of analysis.

Replacement Parts

REQUIRED REAGENTS

Description	Unit	Cat. No.
-------------	------	----------

Free Chlorine Tests

DPD Free Chlorine Reagent Powder Pillows, 25 mL.....	100/pkg	1407099
--	--------------	---------

Total Chlorine Tests

DPD Total Chlorine Reagent Powder Pillows, 25 mL.....	100/pkg	1406499
---	--------------	---------

OPTIONAL REAGENTS

Description	Unit	Cat. No.
-------------	------	----------

Chlorine Standard Solution, 50–75 mg/L, 2-mL	20/pkg	1426820
--	-------------	---------

Chlorine Standard Solution, 50–75 mg/L, 10-mL	16/pkg	1426810
---	-------------	---------

Potassium Iodide Solution, 30 g/L	100 mL MDB*	34332
---	-------------	-------

Spec [√] Secondary Standards Kit, Chlorine, MR	each	2980500
---	-----------	---------

Spec [√] Secondary Standards Kit, Chlorine, HR.....	each	2893300
--	-----------	---------

Sodium Arsenite Solution, 5 g/L.....	100 mL MDB	104732
--------------------------------------	------------------	--------

Sodium Hydroxide Standard Solution, 1 N.....	100 mL MDB	104532
--	------------------	--------

Sulfuric Acid Standard Solution, 1 N	100 mL MDB	127032
--	------------------	--------

* Marked Dropper Bottle

Replacement Parts, continued

Water, deionized	4 L.....	27256
Water, organic-free	500 mL.....	2641549

OPTIONAL APPARATUS

Description	Unit	Cat. No.
Ampule Breaker for 2-mL ampules.....	each.....	2484600
Ampule Breaker Kit.....	each.....	2196800
Batteries, AAA, alkaline	4/pkg.....	4674300
Caps for 10-mL sample cells	12/pkg.....	2401812
Pipet, TenSette [®] , 0.1 to 1.0 mL	each.....	1970001
Pipet Tips, For 19700-01 TenSette [®] Pipet.....	50/pkg.....	2185696
Sample Cells, 10-mL with screw caps.....	6/pkg.....	2427606
Wipes, Disposable, 28 x 37 cm	188/pkg.....	2932800

REPLACEMENT PARTS

Cap for 1-cm/10 mL sample cell.....	each.....	5262600
Instrument Cap/light shield	each.....	5954800
Sample Cells, 1-cm/10-mL	2/pkg.....	4864302

Replacement Parts, continued





Section 2

Instrument Manual

Instrument Operation

Key Functions

Key	Description	Function
	POWER	On/Off/Backlight To turn on the backlight, turn on the instrument, then press and hold the power key until the backlight turns on. Press and hold again to turn off the backlight. This key functions the same in all instrument modes and ranges.
	ZERO/SCROLL	In measurement mode, sets the instrument to zero. In menu mode, scrolls through menu options. Also scrolls numbers when entering or editing a value.
	READ/ENTER	In measurement mode, initiates sample measurement. In menu mode, selects a menu option. When entering numbers, moves one space to the right and executes the function when the entry is complete.

Instrument Operation, continued

Key	Description	Function
	MENU	Enter/Exit the menu mode Press and hold for approximately 5 seconds to enter user-entered method mode.

Menu Selections

Press the **MENU** key to access the menu selections.

Switching Ranges

1. Press the **MENU** key. The display will show “SEL”. A flashing arrow indicates the current range.
2. Press the **READ/ENTER** key to toggle between ranges.
3. Press **MENU** again to accept and exit back to the measurement screen.

Setting the Time

1. Press the **MENU** key, then press the **ZERO/SCROLL** key until the display shows a time in the “00:00” format.

2. Press **READ/ENTER**. The digit to be edited will flash.
3. Use the **ZERO/SCROLL** key to change the entry, then press **READ/ENTER** to accept and advance to the next digit. The time is entered in 24-hour format.

Recalling Stored Measurements

1. Press the **MENU** key, then press the **ZERO/SCROLL** key until the display shows RCL. The instrument automatically stores the last 10 measurements.
2. In RCL, press **READ/ENTER** to recall the stored measurements, beginning with the most recent measurement taken. The meter stores the measurement number as 01 (most recent) through 10 (oldest), the time the measurement was taken, and the measurement value. The **ZERO/SCROLL** key allows for selection of a specific measurement by number. The **READ/ENTER** key scrolls through all stored data points.



Battery Installation

[Figure 1 on page 2—7](#) provides an exploded view of battery installation.

1. Unhook the latch and remove the battery compartment cover. The polarities are shown on the battery holder.
2. Place the four batteries provided with the instrument in the holder as indicated and replace the battery compartment cover. The display will show the software version number (e.g., “P 1.6”) after correct battery installation.

When replacing discharged batteries, always replace the complete set of four alkaline batteries. **Rechargeable batteries are not recommended** and cannot be recharged in the instrument.

Note: *The Low Battery icon will appear on the display when the batteries have 10% battery life remaining. The battery icon will flash when the batteries are too low to complete measurements. See [Instrument Keys and Display on page 1—13](#).*

Figure 1 Battery Installation

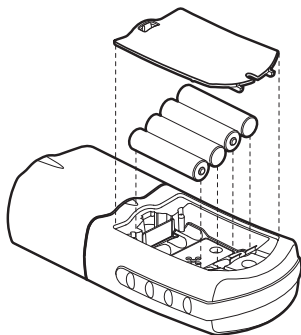

Instrument Operation, continued

Error Codes

When the instrument cannot perform the function initiated by the operator, an error message will appear in the display. Refer to the appropriate message information below to determine what the problem is and how it can be corrected. Resolve error messages in the order that they appear on the display. Service Centers are listed in [page 2—23](#).

Error Messages

1. E-0 No Zero (User mode)

Error occurs when trying to read a standard in the user calibration mode before setting the meter to zero.

- Zero the instrument on an appropriate blank.

2. E-1 Ambient Light Error

There is too much light present to take a valid measurement.

- Verify instrument cap is correctly seated.
- If the problem persists, contact a Service Center ([page 2—23](#)).

Error Codes, continued

3. E-2 LED Error

The LED (light source) is out of regulation.

- Replace batteries.
- Verify LED lights up (inside the cell holder) when the **READ/ENTER** or **ZERO/SCROLL** key is pressed.
- If the problem persists, contact a Service Center ([page 2—23](#)).

Note: *When an E-1 or E-2 error occurs on a measurement, the display will show “_._”. (The decimal place is determined by the chemistry.) If the E-1 or E-2 error occurs while zeroing the meter, the meter must be zeroed again.*

4. E-3 Standard Adjust Error

The value obtained on the prepared standard exceeds the adjustment limits allowed for the standard concentration, or the concentration of the standard is outside the concentration range allowed for standard calibration adjust.

- Prepare the standard and rerun according to the procedure.
- Prepare a standard at or near the recommended concentrations given in the procedure.

- Verify that the concentration of the standard has been entered correctly.
- If the problem persists, contact a Service Center ([page 2—23](#)).

5. **E-6 Abs Error (User mode)**

Indicates that the absorbance value is invalid, or indicates an attempt to make a curve with less than two points.

- Enter or measure the absorbance value again.
- If the problem persists, contact a Service Center ([page 2—23](#)).

6. **E-7 Standard Value Error (User mode)**

Standard concentration is equal to another standard concentration that is already entered.

- Enter the correct standard concentration.
- If the problem persists, contact a Service Center ([page 2—23](#)).

Error Codes, continued

7. E-9 Flash Error

The meter is unable to save data.

- If the problem persists, contact a Service Center ([page 2—23](#)).

8. Underrange—flashing number below stated test range

- Verify instrument cap is correctly seated.
- Check zero by measuring a blank. If error recurs, re-zero the instrument.
- If the problem persists, contact a Service Center ([page 2—23](#)).

9. Overrange—flashing number above stated test range

Note: Flashing value will be 10% over the upper test limit.

- Check for light blockage.
- Dilute and retest sample.

Standard Calibration Adjust

The Pocket Colorimeter™ II instrument is factory-calibrated and ready for use without user calibration. Use of the factory calibration is recommended unless the user is required to generate a calibration. The Standard Calibration Adjust can be used to meet regulatory requirements.

This feature allows the factory default calibration curve to be adjusted with a known standard. Use the standard described in the procedure.

1. Place a blank in the meter (in measurement mode). Press **ZERO/SCROLL**.
2. Place the reacted standard in the meter. Press **READ/ENTER**.
3. Press **MENU**, then press **ZERO/SCROLL** until the display shows “SCA”.
4. Press **READ/ENTER** to display the standard calibration adjust value.
5. Press **READ/ENTER** to adjust the curve to the displayed value. The meter will return to the measurement mode and the Calibration Adjusted icon will appear in the display window.

If an alternate concentration is used, or if a standard concentration is not given:

6. Repeat steps 1–4.

Standard Calibration Adjust, continued

7. Press **ZERO/SCROLL** to access the Edit function, then press **READ/ENTER** to begin editing. The digit to be edited will flash. Use the **ZERO/SCROLL** key to change the entry, then press **READ/ENTER** to accept and advance to the next digit.

When the last digit is entered, press **READ/ENTER** and the meter will adjust the curve to the value entered. The meter will return to measurement mode and the Calibration Adjusted icon will appear in the display window.

To turn off Standard Calibration Adjust (SCA):

1. Press **MENU**.
2. Press **ZERO/SCROLL** until “SCA” appears in the display.
3. Press **READ/ENTER**, then press **ZERO/SCROLL** until “Off” is shown.
4. Press **READ/ENTER** to turn off SCA.

Note: *Perform another standard calibration adjust to turn SCA on again.*

Certification

Hach Company certifies this instrument was tested thoroughly, inspected, and found to meet its published specifications when it was shipped from the factory.

The Pocket Colorimeter™ II instrument has been tested and is certified as indicated to the following instrumentation standards:

EMC Immunity:

Per **89/ 336/ EEC EMC: EN 61326: 1998** (Electrical Equipment for measurement, control and laboratory use—EMC requirements). Supporting test records by

Hach Company, certified compliance by Hach Company.

Standard(s) include:

IEC 1000-4-2: 1995 (EN 61000-4-2: 1995) Electro-Static Discharge Immunity (Criteria B)

IEC 1000- 4- 3: 1995 (EN 61000- 4- 3: 1996) Radiated RF Electro- Magnetic Field Immunity (Criteria A)

Additional Immunity Standard(s) include:

ENV 50204: 1996 Radiated Electromagnetic Field from Digital Telephones

Certification, continued

(Criteria A) Radio Frequency Emissions:

Per **89/ 336/ EEC EMC: EN 61326: 1998** (Electrical Equipment for measurement, control and laboratory use—EMC requirements) “Class B” emission limits. Supporting test records from Hach EMC Test Facility, certified compliance by Hach Company.

Additional Radio Frequency Emissions Standard(s) include:
EN 55022 (CISPR 22), Class B emissions limits.

Canadian Interference-causing Equipment Regulation, IECS-003, Class A: Supporting test records from Hach EMC Test Facility, certified compliance by Hach Company.

This Class A digital apparatus meets all requirements of the Canadian Interference-causing Equipment Regulations.

Cet appareil numérique de la classe A respecte toutes les exigences du Règlement sur le matériel brouilleur du Canada.

FCC Part 15, Class “A” Limits: Supporting test records from Hach EMC Test Facility, certified compliance by Hach Company.

This device complies with Part 15 of the FCC Rules. Operation is subject to the following two conditions:

(1) This device may not cause harmful interference, and (2) This device must accept any interference received, including interference that may cause undesired operation. Changes or modifications to this unit not expressly approved by the party responsible for compliance could void the user's authority to operate the equipment.

This equipment has been tested and found to comply with the limits for a Class A digital device, pursuant to Part 15 of the FCC Rules. These limits are designed to provide reasonable protection against harmful interference when the equipment is operated in a commercial environment. This equipment generates, uses, and can radiate radio frequency energy and, if not installed and used in accordance with the instruction manual, may cause harmful interference to radio communications. Operation of this equipment in a residential area is likely to cause harmful interference, in which case the user will be required to correct the interference at his own expense. The following techniques of reducing the interference problems are applied easily.

Certification, continued

1. Remove power from the Pocket Colorimeter instrument by removing one of its batteries to verify that it is or is not the source of the interference.
2. Move the Pocket Colorimeter instrument away from the device receiving the interference.
3. Reposition the receiving antenna for the device receiving the interference.
4. Try combinations of the above.



GENERAL INFORMATION

At Hach Company, customer service is an important part of every product we make.

With that in mind, we have compiled the following information for your convenience.

How to Order

By Telephone:

6:30 a.m. to 5:00 p.m. MST
Monday through Friday
(800) 227-HACH (800-227-4224)
U.S.A.

By FAX:

(970) 669-2932 (Hach Loveland)

Information Required:

- Hach account number (if available)
- Billing address
- Shipping address
- Your name and phone number
- Purchase order number
- Catalog number
- Brief description or model number
- Quantity

By Mail:

Hach Company
P.O. Box 389
Loveland, Colorado 80539-0389

For order information by E-mail:

orders@www.hach.com

How to Order, continued

Technical and Customer Service (USA only)

Hach Technical and Customer Service Department personnel are eager to answer questions about our products and their use and to take your orders. Specialists in analytical methods, they are happy to put their talents to work for you.

Call **1-800-227-4224** or E-mail **techhelp@hach.com**.

International Customers

Hach maintains a worldwide network of dealers and distributors. To locate the representative nearest you, send E-mail to **intl@hach.com** or call (970) 669-3050.

In Canada

Hach Instrument Service Centre, Winnipeg, Manitoba, Canada

Telephone: (204) 632-5598; (800) 665-7635

FAX: (204) 694-5134

Repair Service

Authorization must be obtained from Hach Company before sending any items for repair. Please contact the Hach Service Center serving your location.

In the United States:

Hach Company
100 Dayton Avenue
Ames, Iowa 50010
(800) 227-4224 (USA only)
FAX: (515) 232-3835

Canada:

Hach Sales & Service Canada Ltd.
1313 Border Street, Unit 34
Winnipeg, Manitoba R3H 0X4
(800) 665-7635 (Canada only)
Telephone: (204) 632-5598
FAX: (204) 694-5134
E-mail: canada@hach.com

Latin America, Caribbean, Africa, Far East, Indian Subcontinent:

Hach Company World Headquarters
P.O. Box 389
Loveland, Colorado 80539-0389 U.S.A.
Telephone: (970) 669-3050
FAX: (970) 669-2932
E-mail: intl@hach.com.

Europe, the Middle East, or Mediterranean Africa:

HACH Company, c/o
Dr. Bruno Lange GmbH & CO. KG
Willstätterstr. 11
40549 Düsseldorf, Germany
Telephone: +49/(0)211/52 88-0
FAX: +49/(0)211/52 88-134

Warranty

Hach Company warrants this product to the original purchaser against any defects that are due to faulty material or workmanship for a period of **two years from date of shipment**.

In the event that a defect is discovered during the warranty period, Hach Company agrees that, at its option, it will repair or replace the defective product or refund the purchase price, excluding original shipping and handling charges. Any product repaired or replaced under this warranty will be warranted only for the remainder of the original product warranty period.

This warranty does not apply to consumable products such as chemical reagents; or consumable components of a product, such as, but not limited to, lamps and tubing.

Contact Hach Company or your distributor to initiate warranty support. Products may not be returned without authorization from Hach Company.

Limitations

This warranty does not cover:

- damage caused by acts of God, natural disaster, labor unrest, acts of war (declared or undeclared), terrorism, civil strife or acts of any governmental jurisdiction

- damage caused by misuse, neglect, accident or improper application or installation
- damage caused by any repair or attempted repair not authorized by Hach Company
- any product not used in accordance with the instructions furnished by Hach Company
- freight charges to return merchandise to Hach Company
- freight charges on expedited or express shipment of warranted parts or product
- travel fees associated with on-site warranty repair

This warranty contains the sole express warranty made by Hach Company in connection with its products. All implied warranties, including without limitation, the warranties of merchantability and fitness for a particular purpose, are expressly disclaimed.

Some states within the United States do not allow the disclaimer of implied warranties and if this is true in your state the above limitation may not apply to

Warranty, continued

you. This warranty gives you specific rights, and you may also have other rights that vary from state to state.

This warranty constitutes the final, complete, and exclusive statement of warranty terms and no person is authorized to make any other warranties or representations on behalf of Hach Company.

Limitation of Remedies

The remedies of repair, replacement or refund of purchase price as stated above are the exclusive remedies for the breach of this warranty. On the basis of strict liability or under any other legal theory, in no event shall Hach Company be liable for any incidental or consequential damages of any kind for breach of warranty or negligence.